

Canon EF LENS

EF85mm f/1.4L IS USM



IMAGE STABILIZER

 ULTRASONIC

ENG

Instructions

Thank you for purchasing a Canon product.

Canon's EF85mm f/1.4L IS USM is a medium telephoto lens for use with EOS cameras.

- "IS" stands for Image Stabilizer.
- "USM" stands for Ultrasonic Motor.

Camera Firmware

Please use the latest version of firmware with the camera in use. For details on whether the firmware is the latest version or not, and for details on updating the firmware, please check the Canon website.

Conventions used in this instruction



Warning to prevent lens or camera malfunction or damage.



Supplementary notes on using the lens and taking pictures.

Safety Precautions

Precautions to ensure that the camera is used safely. Read these precautions thoroughly. Make sure all details are observed in order to prevent risks and injury to the user and other people.

 **Warning** Details pertaining to risks that may result in death or serious injury.

- **Do not look at the sun or a bright light source through the lens or single-lens reflex camera.** Doing so could result in loss of vision. Looking at the sun directly through the lens is especially hazardous.
- **Whether it is attached to the camera or not, do not leave the lens under the sun without the lens cap attached.** This is to prevent the lens from concentrating the sun's rays, which could cause a fire.

 **Caution** Details pertaining to risks that may result in injury.

- **Do not leave the camera in locations subject to high or low temperatures.** This may result in the camera becoming excessively hot or cold, which may cause burns or other injuries when touched.

Caution Details pertaining to risks that may result in damage to property.

- Do not leave the lens in excessive heat such as in a car in direct sunlight. High temperatures can cause the lens to malfunction.

General Precautions

Handling Precautions

- If the lens is taken from a cold environment into a warm one, condensation may develop on the lens surface and internal parts. To prevent condensation in this case, first put the lens into an airtight plastic bag before taking it from a cold to warm environment. Then take out the lens after it has warmed gradually. Do the same when taking the lens from a warm environment into a cold one.
- Please also read any lens related handling precautions listed in your camera's instruction manual.

This device complies with Part 15 of the FCC Rules.

Operation is subject to the following two conditions: (1) This device may not cause harmful interference, and (2) this device must accept any interference received, including interference that may cause undesired operation.

Do not make any changes or modifications to the equipment unless otherwise specified in the instructions. If such changes or modifications should be made, you could be required to stop operation of the equipment.

This equipment has been tested and found to comply with the limits for a class B digital device, pursuant to part 15 of the FCC Rules. These limits are designed to provide reasonable protection against harmful interference in a residential installation. This equipment generates, uses and can radiate radio frequency energy and, if not installed and used in accordance with the instructions, may cause harmful interference to radio communications.

However, there is no guarantee that interference will not occur in a particular installation. If this equipment does cause harmful interference to radio or television reception, which can be determined by turning the equipment off and on, the user is encouraged to try to correct the interference by one or more of the following measures:

- Reorient or relocate the receiving antenna.
- Increase the separation between the equipment and receiver.
- Connect the equipment into an outlet on a circuit different from that to which the receiver is connected.
- Consult the dealer or an experienced radio/TV technician for help.

Nomenclature

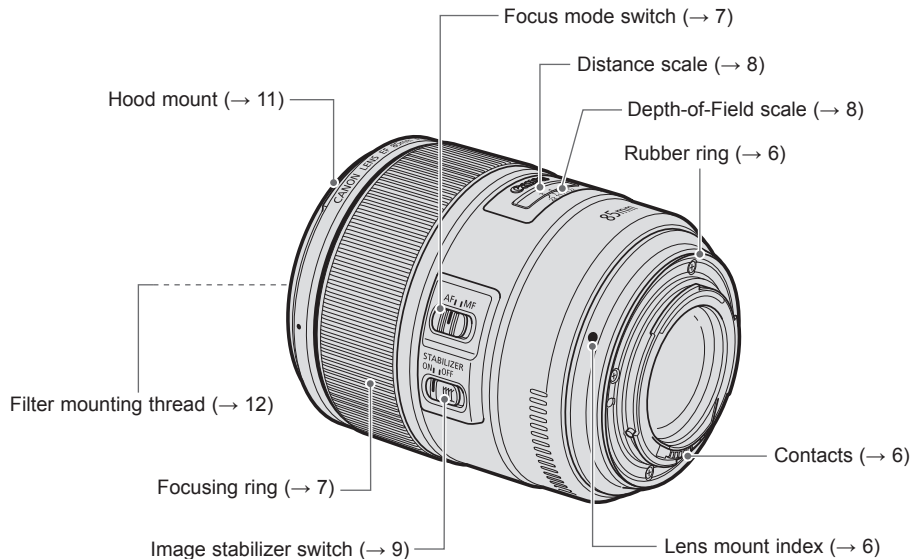

- For detailed information, reference page numbers are provided in parentheses (→ **).

1. Mounting and Detaching the Lens

See your camera's instructions for details on mounting and detaching the lens.

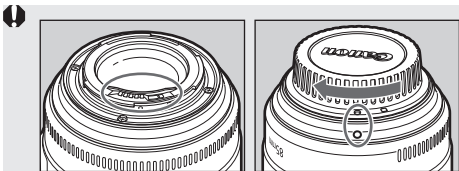

- After detaching the lens, place the lens with the rear end up to prevent the lens surface and contacts from getting scratched.
- Contacts that are scratched, soiled, or have fingerprints on them may result in faulty connections or corrosion, which may lead to malfunctions. If the contacts get soiled, clean them with a soft cloth.
- Attach the lens cap and dust cap when disconnecting the lens. When attaching the dust cap, align the lens mount index with the ○ index of the dust cap and rotate in a clockwise direction as shown in the illustration. Follow the reverse procedure to detach it.

ⓘ The lens mount has a rubber ring for enhanced dust- and water-resistance. The rubber ring may cause slight abrasions around the camera's lens mount, but this will not cause any problems. If the rubber ring becomes worn, it is replaceable by a Canon Service Center at a cost.

2. Setting the Focus Mode

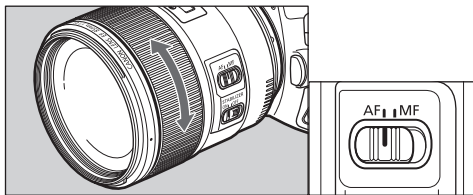

To shoot in autofocus (AF) mode, set the focus mode switch to AF.

To use only manual focusing (MF), set the focus mode switch to MF, and focus by turning the focusing ring.

The focusing ring always works, regardless of the focus mode.

 When AF operation is set to [ONE SHOT], manual focus is possible after autofocus has been completed by continuing to press the shutter button halfway (Full-time manual focus).

3. Infinity Compensation Mark

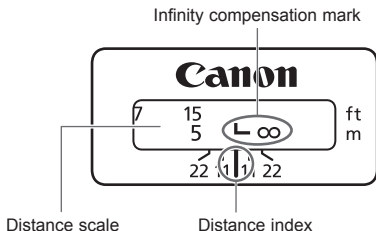

To compensate for shifting of the infinity focus point that results from changes in temperature, there is a margin at the infinity (∞) position. The infinity position at normal temperature is the point at which the vertical line of the distance scale L mark is aligned with the distance index.

 For accurate manual focusing of subjects at infinity, look through the viewfinder or look at the magnified image* on the LCD screen while rotating the focusing ring.

* For cameras with Live View shooting capability.

4. Depth-of-Field Scale

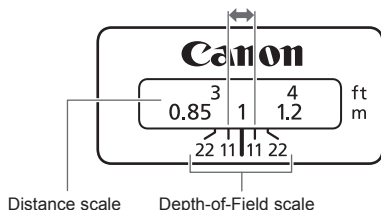

The depth of field is the distance in front of and behind the plane of focus on the subject that appears sharp. The depth of field is indicated by the area between the depth-of-field scale lines below the distance scale.

The number on the scale is the aperture.

 The depth-of-field scale is an approximate indicator.

5. Image Stabilizer

You can use the Image Stabilizer in AF or MF mode. This function provides optimal image stabilization depending on shooting conditions (such as shooting still subjects and following shots).

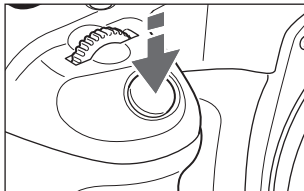
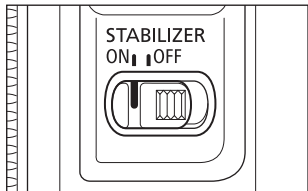

1 Set the STABILIZER switch to ON.

- If you are not going to use the Image Stabilizer, set the switch to OFF.

2 When you press the shutter button halfway, the Image Stabilizer will start operating.

- Make sure the image in the viewfinder is stable, then press the shutter button the rest of the way down to take the picture.



ON



OFF

The Image Stabilizer in this lens is effective for hand-held shots under the following conditions.

- In semi-darkened areas such as indoors or outdoors at night.
- In locations where flash photography is prohibited, such as art museums and theater stages.
- In situations where your footing is uncertain.
- When panning subjects in motion.
- In situations where fast shutter settings cannot be used.

Image Stabilizer



- The Image Stabilizer cannot compensate for a blurred shot caused by a subject that moved.
- Set the STABILIZER switch to OFF when you are taking pictures using the Bulb setting (long exposures). If the STABILIZER switch is set to ON, the Image Stabilizer may introduce errors.
- The Image Stabilizer may not be fully effective if you shoot from a violently shaking vehicle or other transportation.
- The Image Stabilizer consumes more power when set at ON than normal shooting at OFF, resulting in fewer shots and a shorter movie shooting time.
- The Image Stabilizer operates for about two seconds even when your finger is off the shutter button. Do not remove the lens while the stabilizer is in operation. This will cause a malfunction.
- With the EOS-1V/HS, 3, ELAN 7E/ELAN 7/30/33, ELAN 7NE/ELAN 7N/30V/33V, ELAN II/ELAN II E/50/50E, REBEL 2000/300, IX, IX Lite/IX7, and D30, the Image Stabilizer will not work during self-timer operation.



- When shooting a still subject, it compensates for camera shake in all directions.
- It compensates for vertical camera shake during following shots in a horizontal direction, and compensates for horizontal camera shake during following shots in a vertical direction.
- When you use a tripod, the Image Stabilizer should be turned off to save battery power.
- Even with a monopod, the Image Stabilizer will be as effective as during hand-held shooting. However, depending on the shooting conditions, there are cases in which the Image Stabilizer effect may be less effective.
- The Image Stabilizer also operates when the lens is used with an Extension Tube EF12 II or EF25 II.
- Depending on the camera there may be image shake, such as after releasing the shutter. However, this does not affect shooting.
- If you set the camera's Custom Function to change the assigned button to operate the AF, the Image Stabilizer will operate when you press the newly assigned AF button.

6. Hood

The ET-83E hood cuts out unwanted light and protects the front of the lens from rain, snow, and dust.

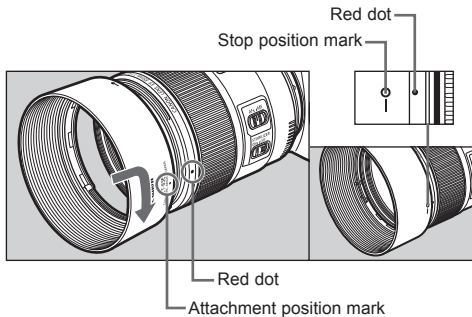

● Attaching

Align the red attachment position mark on the hood with the red dot on the front of the lens, and then rotate the hood in the direction of the arrow until it is firmly attached with the red dot and stop position mark on the hood aligned.

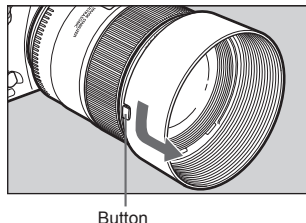

● Removing

Keep your finger pressed down on the button located on the side of the hood, and then rotate the hood in the direction of the arrow until the attachment position mark on the hood is aligned with the red dot on the front of the lens to detach it. The hood can be reverse-mounted on the lens for storage.



- If the hood is not attached properly, vignetting (darkening of the perimeter of the picture) may occur.
- Grasp and rotate the base of the hood when attaching and detaching it. There are cases in which it may become deformed if the hood is rotated with it grasped near to the rim.

7. Filters (sold separately)

You can attach filters to the filter mounting thread on the front of the lens.

-  Only one filter may be attached.
- If you need a polarizing filter, use the Canon Circular Polarizing Filter PL-C B (77 mm).
- Detach the hood when adjusting the polarizing filter.

8. Close-up Lenses (sold separately)

Attaching a 500D (77 mm) Close-up Lens enables close-up photography. It provides a magnification of 0.16x to 0.30x.

-  Close-up Lens 250D cannot be attached because there is no size that fits the lens.
- MF mode is recommended for accurate focusing.

9. Extension Tubes (sold separately)

You can attach extension tube EF12 II or EF25 II for magnified shots. The shooting distance and magnification are shown below.

	Focusing Distance Range (mm)		Magnification (×)	
	Close distance	Long distance	Close distance	Long distance
EF12 II	492	698	0.26	0.15
EF25 II	375	407	0.43	0.33

-  MF mode is recommended for accurate focusing.

Specifications

Focal Length/Aperture	85mm f/1.4
Lens Construction	10 groups, 14 elements
Minimum Aperture	f/22
Angle of View	Diagonal: 28°30', Vertical: 16°, Horizontal: 24°
Min. Focusing Distance	0.85 m/2.79 ft.
Max. Magnification	0.12x
Field of View	Approx. 189 x 280 mm/7.44 x 11.02 inch (at 0.85 m/2.79 ft.)
Filter Diameter	77 mm
Max. Diameter and Length	88.6 x 105.4 mm/3.49 x 4.15 inch
Weight	Approx. 950 g/33.5 oz
Hood	ET-83E
Lens Cap	E-77 II
Case	LP1219

- The lens length is measured from the mount surface to the front end of the lens. Add 24.2 mm when including the lens cap and dust cap.
- The size and weight listed are for the lens only, except as indicated.
- Extenders cannot be used with this lens.
- Aperture settings are specified on the camera.
- All data listed is measured according to Canon standards.
- Product specifications and appearance are subject to change without notice.

Canon