

Canon EF LENS

EF70-200mm F2.8L IS USM

Instruction

70-200mm LENS EF 70-200mm 1:2.8 L IS USM
ULTRASONIC

IMAGE STABILIZER
ULTRASONIC

使用本镜头前，请仔细阅读本说明书。
请将说明书妥善保存，以备将来参考。

Thank you for purchasing a Canon USM lens.

The Canon EF 70-200mm f/2.8L IS USM is a high-performance, telephoto zoom lens dedicated to Canon EOS cameras. It is equipped with an Image Stabilizer to help preventing blurred shots due to camera shake during slow shutter speeds.

In the lens name, "IS" stands for Image Stabilizer, and "USM" for Ultrasonic Motor.

Handling Cautions

If the lens is taken from a cold environment into a warm one, condensation may develop on the lens surface and internal parts. To prevent condensation in this case, first put the lens into an airtight plastic bag before taking it from a cold to warm environment. Then take out the lens after it has warmed gradually. Do the same when taking the lens from a warm environment into a cold one.

Features

1. The four UD elements help capture very sharp and clear pictures with outstanding image delineation.
2. The Image Stabilizer gives the equivalent effect of a shutter speed three stops faster.
3. Ultrasonic motor (USM) for fast, quiet focusing.
4. Manual focusing enabled during AF (autofocusing).
5. A truly round aperture hole results in a nicer background blur.
6. Compatible with Extenders.
7. Sealed construction for higher resistance against dust and moisture.

Conventions used in this instruction



Warning to prevent bad influence on picture taking.



Supplementary notes on using the lens and taking pictures.

Safety Precautions

This device complies with Part 15 of the FCC Rules. Operation is subject to the following two conditions: (1) This device may not cause harmful interference, and (2) this device must accept any interference received, including interference that may cause undesired operation.

Do not make any changes or modifications to the equipment unless otherwise specified in the instructions. If such changes or modifications should be made, you could be required to stop operation of the equipment.

This equipment has been tested and found to comply with the limits for a class B digital device, pursuant to part 15 of the FCC Rules. These limits are designed to provide reasonable protection against harmful interference in a residential installation. This equipment generates, uses and can radiate radio frequency energy and, if not installed and used in accordance with the instructions, may cause harmful interference to radio communications.

However, there is no guarantee that interference will not occur in a particular installation. If this equipment does cause harmful interference to radio or television reception, which can be determined by turning the equipment off and on, the user is encouraged to try to correct the interference by one or more of the following measures:

- Reorient or relocate the receiving antenna.
 - Increase the separation between the equipment and receiver.
 - Consult the dealer or an experienced radio/TV technician for help.
-

This digital apparatus does not exceed the Class B limits for radio noise emissions from digital apparatus as set out in the interference-causing equipment standard entitled "Digital Apparatus", ICES-003 of the Industry Canada.

 N118

Nomenclature

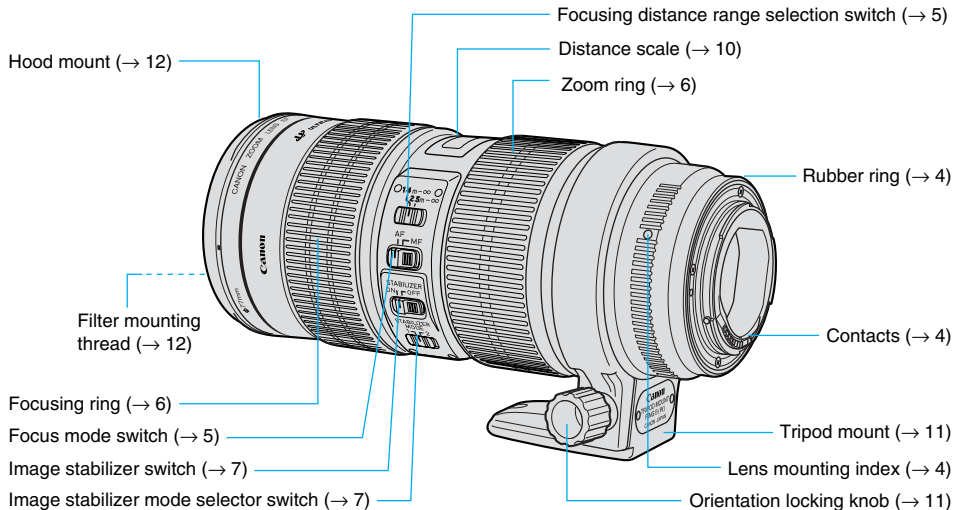

- Numbers in parentheses indicate reference page numbers.

1. Mounting and Detaching the Lens

See your camera's instructions for details on mounting and detaching the lens.

⚠ The lens mount has a rubber ring for enhanced water- and dust-resistance. The rubber ring may cause slight abrasions around the camera's lens mount, but this will not cause any problems. If the rubber ring becomes worn, it is replaceable by a Canon Service Center at cost.

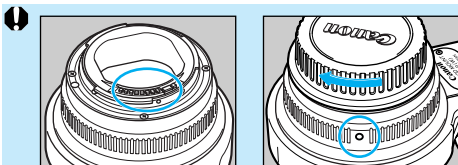

- After detaching the lens, put it down with the contacts upwards, to avoid damaging the contacts or lens surface.
- If the contacts are dirty, scratched, or soiled with fingerprints, etc., corrosion or a faulty connection or operation may result.
- Always attach the dust cap to the lens whenever it is not mounted on the camera. To attach the dust cap, align the mark on the dust cap with the mark on the lens and turn the dust cap clockwise. To remove the dust cap, turn it counterclockwise.

2. Setting the Focus Mode

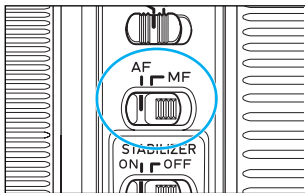

If you are going to take pictures using autofocus, set the focus mode switch to AF. To focus manually, set the focus mode switch to MF and turn the focusing ring.

3. Switching the Focusing Distance Range

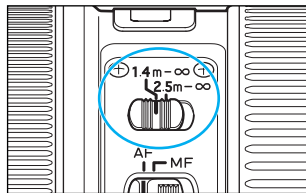

You can set the focusing distance range to 1.4 m/4.6 ft. to infinity or 2.5 m/8.2 ft. to infinity. By setting the suitable focusing distance range, the actual autofocusing time can be shorter.

- Before switching the focusing distance range, turn the focusing ring so that the current focusing distance is within the focusing distance range you want to switch to.
- If the current focusing distance is not within the focusing distance range you switch to, the lens focusing may first stop at the start of the focusing range. This is normal and not a malfunction. Just press the shutter button halfway again to resume normal autofocusing.

4. Zooming

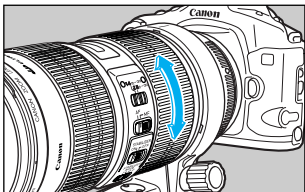

To zoom, turn the zoom ring.

5. Focusing Ring

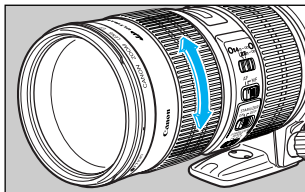

The focusing ring can be used at any time regardless of the focus mode.

- After autofocusing with the camera in ONE SHOT AF mode, you can adjust the focus by keeping the shutter button pressed halfway and turning the focusing ring.



- Be sure to finish zooming before focusing. Zooming after focusing can affect the focus.
- For flash pictures, use an external, EOS-dedicated Speedlite instead of the camera's built-in flash. The long lens may partially obstruct the light of the built-in flash.

6. Image Stabilizer Settings

The image stabilizer function can be used in both AF and MF focus modes.

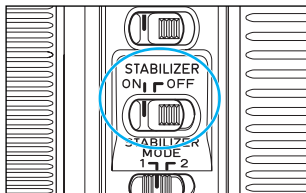

1 Set the STABILIZER switch to ON.

- If you are not going to use the image stabilizer function, set the switch to OFF.

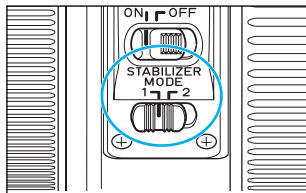

2 Select the stabilizer mode.

- Select MODE 1 for standard photography. MODE 1 corrects all vibrations no matter whether the camera is being held horizontally, vertically, or at an angle.
- To pan a moving subject, select MODE 2. MODE 2 corrects vibrations and shaking only in the direction at right angles to the camera's panning movement.

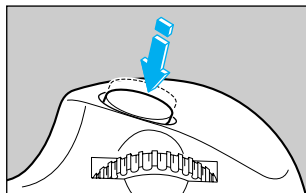

3 Press the shutter button down halfway to check the stabilization.

- Make sure the image in the viewfinder is stable, then press the shutter button all the way down to take pictures.

7. Tips on Using the Image Stabilizer

The image stabilizer function is particularly effective for hand-held photography in the following situations:

● MODE 1



ON

OFF

- ① In semi-darkened areas such as indoors or outdoors at night.
- ② In locations where flash photography is prohibited, such as art museums and theater stages.
- ③ In situations where fast shutter settings cannot be used.
- ④ In situations where your footing is uncertain.

● MODE 2



ON

OFF

- ① When panning subjects in motion.
- ② When following subjects that are moving erratically.

* We recommend MODE 1 for all other situations.

Tips on Using the Image Stabilizer



- The Image Stabilizer cannot compensate for a blurred shot caused by a subject that moved.
- Set the STABILIZER switch to OFF when you are taking pictures using the Bulb setting (long exposures). If the STABILIZER switch is set to ON, the image stabilizer function may introduce errors.
- The Image Stabilizer might not be fully effective in the following cases:
 - You move the camera for a panned shot.
 - You shoot while riding on a bumpy road.
- Compared to using a normal non-IS lens, fewer shots can be taken when you use an Image Stabilizer lens because more power is consumed.
- The image stabilizer operates for about two seconds even when your finger is off the shutter button. Do not remove the lens while the stabilizer is in operation. This will cause a malfunction.
- With the EOS-1V/HS, 3, 30/33/Elan7/7E, 30V/33V/Elan7N/7NE, Elan II/Elan II E/50/50 E, 300/Rebel2000, IX, and D30, the Image Stabilizer will not work during self-timer operation.



- When you use a tripod, the Image Stabilizer should be turned off to save battery power.
- The stabilizer is equally effective for hand-held photography and photography with a monopod.
- The Image Stabilizer function also operates when the lens is used with the EF12 II or EF25 II Extension Tube, and the EF1.4X II or EF2X II Extender.
- If you set the camera's Custom Function to change the assigned button to operate the AF, the Image Stabilizer will operate when you press the newly assigned AF button.

8. Infinity Compensation Mark

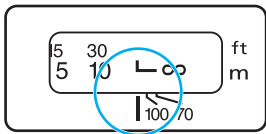

To compensate for shifting of the infinity focus point that results from changes in temperature, you can rotate the distance scale slightly past the normal infinity focus mark.

- The infinity position at normal temperature is the point at which the vertical line of the **L** mark is aligned with the distance indicator.
- For accurate manual focusing on subjects at infinity distance, look through the viewfinder to confirm focusing while rotating the focusing ring.

9. Infrared Index

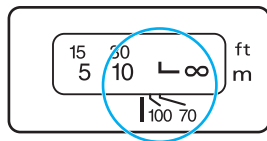

The infrared index corrects the focus setting when using monochrome infrared film. Focus on the subject manually, then adjust the distance setting by moving the focusing ring to the corresponding infrared index mark.

- The compensation amount differs depending on the focal length. Use the indicated focal length as a guide when setting the compensation amount.



Some EOS cameras cannot use infrared film. See the instructions for your EOS camera.



- The infrared index position is based on a wavelength of 800 nm.
- Be sure to observe the manufacturer's instructions when using infrared film.
- Use a red filter when you take the picture.

10. Using the Tripod Mount

Adjusting the Tripod Mount

Loosening the orientation locking knob on the tripod mount allows you to turn the lens and camera freely. This is useful when you want to switch the camera between horizontal and vertical positions while it is mounted on a tripod. Once you have set the camera to the desired position, tighten the locking knob firmly.

Detaching the Tripod Mount

First remove the lens from the camera and then remove the tripod mount from the lens as shown below. To attach the tripod mount, reverse the procedure.

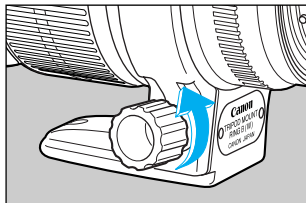

- 1 Loosen the orientation locking knob.

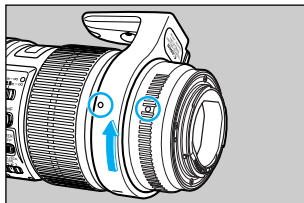

- 2 Turn the tripod collar to align the red dots on the collar and lens.

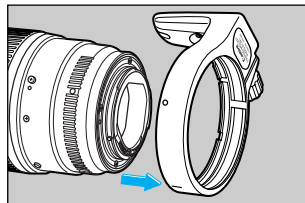

- 3 Slide off the tripod collar away from the rear of the lens.

11. Hood

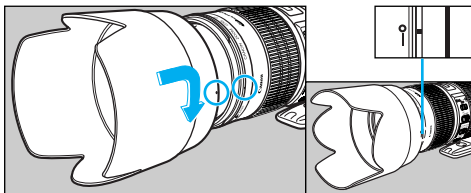

The ET-86 hood can keep unwanted light out of the lens, and also protects the front of the lens from rain, snow, and dust.

To attach the hood, align the hood's attachment position mark with the red dot on the front of the lens, then turn the hood clockwise until the lens's red dot is aligned with the hood's stop position mark.

The hood can be reverse-mounted on the lens for storage.



- Part of the picture may be blocked if the hood is not attached properly.
- To attach (remove) the hood, grasp the base of the hood and turn it clockwise (counterclockwise). Do not hold the hood by the outer rim as this could result in the hood being distorted if too much pressure is applied.

12. Filters (Optional)

You can attach filters to the filter mounting thread on the front of the lens.

- If you need a polarizing filter, use Canon's PL-C 77 mm II polarizing filter. Note that you must remove the hood before adjusting the polarizing filter.
- When the PL-C 77mm II polarizing filter is attached, the lens cap cannot be attached.

13. Extension Tubes (Optional)

With Extension Tube EF 12 II or EF 25 II, the camera-to-subject distance and image magnification will be as follows:

		Camera-to-Subject Distance (mm)		Magnification	
		Near	Far	Near	Far
EF12 II	70mm	550	624	0.22×	0.17×
	200mm	1110	3401	0.24×	0.06×
EF25 II	70mm	402	407	0.41×	0.38×
	200mm	929	1737	0.32×	0.14×

14. Extenders (Optional)

With Extender EF 1.4X II or EF 2X II attached, the lens specifications will change as follows:

Item	With EF1.4X II Extender	With EF2X II Extender
Focal length (mm)	98 – 280	140 – 400
Aperture	f/4 – 45	f/5.6 – 64
Angle of view	Diagonal	25°20' – 9°20'
	Vertical	13°50' – 5°10'
	Horizontal	20°50' – 7°40'
Maximum magnification (×)	0.24	0.36

-  Do not attach more than one Extender on the same lens. Having more than one Extender on the lens will degrade the optical performance and cause exposure errors by the camera's built-in exposure metering.
- If you use an Extender on the lens mounted on a EOS A2/A2E/5, set the exposure compensation to -1/2 stop for the EF 1.4X II or -1 stop for the EF 2X II.

-  AF is possible with Extender.
- When an Extender is attached, the AF speed will become slower by design to retain proper AF control.

15. Specifications

Image Size	24 × 36 mm
Focal Length & Max. Aperture	70 – 200 mm, f/2.8
Lens Construction	23 elements in 18 groups
Min. Aperture	f/32
Angle of View	Diagonal: 34° – 12° Vertical: 19°30' – 7° Horizontal: 29° – 10°
Min. Focusing Distance	1.4 m / 4.6 ft.
Max. Magnification & Field of view	0.17 × (at 200 mm), 373 × 559 – 140 × 211mm / 14.6 × 21.8 – 5.5 × 8.2 inch (at 1.4 m)
Filter Diameter	φ 77 mm
Lens Hood	ET-86
Max. Diameter & Length	φ 86.2 × 197mm / φ 3.4 × 7.7 inch
Weight	1470g / 51.5oz (or 1590g / 55.7oz with the tripod collar)
Lens Cap	E-77U
Case	LZ 1324

- The lens length is measured from the mount surface to the front end of the lens.
- The size and weight listed are for the lens only, except as indicated.
- Aperture settings are specified on the camera.
- All the specifications above are based on Canon's testing and measuring standards.
- Specifications and appearance are subject to change without notice.

Canon