

Canon EF LENS

EF100mm f/2.8 MACRO USM



ULTRASONIC

ENG

Instruction

Thank you for purchasing a Canon product.

The Canon EF100mm f/2.8 MACRO USM is a macro lens that can be used for normal photography as well as macro photography up to 1x magnification. It is dedicated to Canon EOS cameras.

- "USM" stands for Ultrasonic Motor.

Features

1. The three-group floating system results in excellent delineation at all focusing distances from life-size to infinity.
2. Ultrasonic motor (USM) for quick and quiet autofocus.
3. A Canon macro flash makes it easy to take close-up pictures with a flash. The inner focusing mechanism enables AF photography while the macro flash is attached.

Conventions used in this instruction



Warning to prevent lens or camera malfunction or damage.



Supplementary notes on using the lens and taking pictures.

Safety Precautions

Safety Precautions

- **Do not look at the sun or a bright light source through the lens or camera.** Doing so could result in loss of vision. Looking at the sun directly through the lens is especially hazardous.
- **Whether it is attached to the camera or not, do not leave the lens under the sun without the lens cap attached.** This is to prevent the lens from concentrating the sun's rays, which could cause a fire.

Handling Cautions

- **If the lens is taken from a cold environment into a warm one, condensation may develop on the lens surface and internal parts.** To prevent condensation in this case, first put the lens into an airtight plastic bag before taking it from a cold to warm environment. Then take out the lens after it has warmed gradually. Do the same when taking the lens from a warm environment into a cold one.
- Do not leave the lens in excessive heat such as in a car in direct sunlight. **High temperatures can cause the lens to malfunction.**

This device complies with Part 15 of the FCC Rules. Operation is subject to the following two conditions: (1) This device may not cause harmful interference, and (2) this device must accept any interference received, including interference that may cause undesired operation.

Do not make any changes or modifications to the equipment unless otherwise specified in the instructions. If such changes or modifications should be made, you could be required to stop operation of the equipment.

This equipment has been tested and found to comply with the limits for a class B digital device, pursuant to part 15 of the FCC Rules. These limits are designed to provide reasonable protection against harmful interference in a residential installation. This equipment generates, uses and can radiate radio frequency energy and, if not installed and used in accordance with the instructions, may cause harmful interference to radio communications.

However, there is no guarantee that interference will not occur in a particular installation. If this equipment does cause harmful interference to radio or television reception, which can be determined by turning the equipment off and on, the user is encouraged to try to correct the interference by one or more of the following measures:

- Reorient or relocate the receiving antenna.
- Increase the separation between the equipment and receiver.
- Consult the dealer or an experienced radio/TV technician for help.

This Class B digital apparatus complies with Canadian ICES-003.

Nomenclature

Hood and Macro Ring Lite mount (→ 5, 11)

Focus mode switch (→ 4)

Distance scale (→ 8)

Tripod mounting location (→ 8)

Filter mounting thread
(→ 10)

Focusing ring (→ 4)

Focusing distance range selection switch (→ 5)

Contacts (→ 4)

Lens mount index (→ 4)

Tripod mount adapter groove (→ 8)

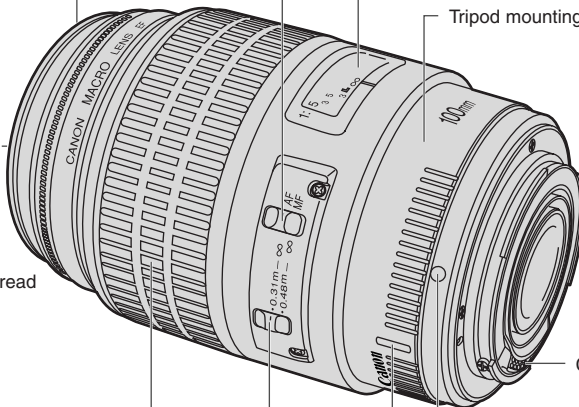

For detailed information, reference page numbers are provided in parentheses (→ **).

1. Mounting and Detaching the Lens

See your camera's instructions for details on mounting and detaching the lens.

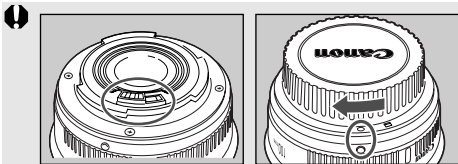

- After detaching the lens, place the lens with the rear end up to prevent the lens surface and electrical contacts from getting scratched.
- If the contacts get soiled, scratched, or have fingerprints on them, corrosion or faulty connections can result. The camera and lens may not operate properly.
- If the contacts get soiled or have fingerprints on them, clean them with a soft cloth.
- If you remove the lens, cover it with the dust cap. To attach it properly, align the lens mount index and the ○ index of the dust cap as shown in the diagram, and turn clockwise. To remove it, reverse the order.

2. Setting the Focus Mode

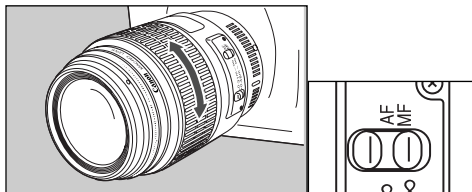

To shoot in autofocus (AF) mode, set the focus mode switch to AF.

To use only manual focusing (MF), set the focus mode switch to MF, and focus by turning the focusing ring. The focusing ring always works, regardless of the focus mode.

 After autofocusing in ONE SHOT AF mode, focus manually by pressing the shutter button halfway and turning the focusing ring. (Full-time manual focus)

3. Switching the Focusing Distance Range

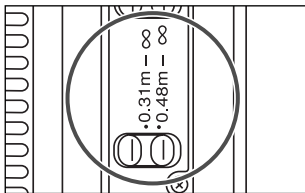

You can set the focusing distance range to 0.31 m/1.0 ft. to infinity or 0.48 m/1.6 ft. to infinity. By setting the suitable focusing distance range, the actual autofocus time can be shorter.

 If you autofocus outside the set focusing distance range, the lens may stop focusing at the start of the focusing range; however, this is not a malfunction. Press the shutter release button halfway again.

4. Hood (Sold Separately)

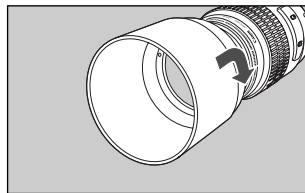

The ET-67 hood can keep unwanted light out of the lens, and also protects the front of the lens from rain, snow, and dust.

Attach and align the hood to the hood mount on the front of the lens, and turn the hood as shown by the arrow to secure it.

The hood can be reverse-mounted on the lens for storage.

-  • Part of the picture may be blocked if the hood is not attached properly.
- When attaching or detaching the hood, grasp the base of the hood to turn it. To prevent deformation, do not grasp the rim of the hood to turn it.
 - Remove the hood when using the macro flash.

5. Picture Taking

Normal Photography

The lens can be used as a medium-telephoto lens for normal photography such as portraits.

Closeup Photography

Close-up photos up to 1x (life-size) magnification are possible. The minimum focusing distance of 31 cm is the distance from the subject to the focal plane. The working distance from the front of the lens to the subject is about 15 cm.

When focusing, you can give priority to framing or to magnification.

[Framing Priority]

While looking through the viewfinder and framing the subject, focus with the AF or MF mode.

[Magnification Priority]

1. Set the lens' focus mode switch to MF.

2. Set the magnification.

While referring to the magnification scale on the lens, turn the focusing ring to the desired magnification.

3. Focus the subject.

While looking through the viewfinder, move the camera forward or back to find the point of focus.

4. Touch up the focus.

Turn the focusing ring for fine focusing.



Since macro shots have a very shallow depth of field, focus carefully to obtain proper sharpness.



- The magnification refers to the ratio between the subject's size and the corresponding image size on the focal plane. On the distance index, it is indicated as 1:x.
- To prevent camera shake, using a Remote Switch (both sold separately) and tripod is recommended.
- To check the depth of field, press the camera's depth-of-field preview button.

6. About Exposure

Setting the Exposure

When taking photographs using TTL metering, no exposure compensation is necessary to meter the light coming through the lens.

With TTL metering, AE (autoexposure) is possible at all focusing distances. Just set the desired picture-taking mode, then check the shutter speed and aperture before taking the picture.

Magnification and Effective f-number

The aperture displayed by the camera assumes that the focus is set to infinity. The actual aperture (effective f-number) becomes darker (effective f-number increases) at closer focusing distances (magnification increases). This does not cause exposure problems for normal picture-taking. However, for closeup photography, you cannot ignore the change in the effective f-number.

When you use a handheld exposure meter to set the exposure, you must take into account the exposure factor shown in the following table.

Magnification	1 : 5	1 : 3	1 : 2	1 : 1.5	1 : 1
Effective f/No.	3.6	4.1	4.6	5.0	5.9
Exposure Factor (stops)*	$+\frac{2}{3}$	+1	$+1\frac{1}{3}$	$+1\frac{2}{3}$	+2
	$+\frac{1}{2}$	+1	$+1\frac{1}{2}$		+2

* Upper values: 1/3 stops. Lower values: 1/2 stops.



- The correct exposure for a close-up shot largely depends on the subject. Therefore, try to bracket the exposure for the same subject.
- Using aperture-priority AE (**Av**) or Manual (**M**) picture-taking modes are recommended for macro photography as it is easy to adjust depth of field and exposure in these modes.



If your eye will not be covering the eyepiece when the picture is taken (with remote control operation, etc.), use the eyepiece shutter or eyepiece cover. This prevents stray light from entering the eyepiece and throwing off the proper exposure.

7. Infinity Compensation Mark

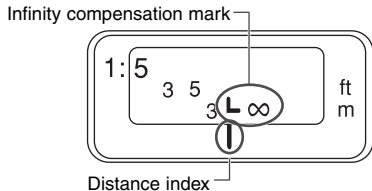

To compensate for shifting of the infinity focus point that results from changes in temperature. The infinity position at normal temperature is the point at which the vertical line of the L mark is aligned with the distance indicator on the distance scale.

- For accurate manual focusing on subjects at infinity distance, look through the viewfinder while rotating the focusing ring.

8. Using the Tripod Mount (Sold Separately)

To mount the lens on a tripod, Tripod mount ring B (B) and the tripod mount adapter (sold separately) for the EF100mm f/2.8 Macro USM will be necessary.

Tripod mount adapter

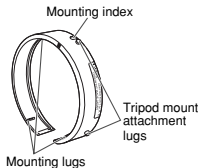

Tripod mount ring B (B)

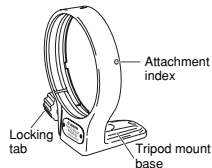



- When switching to vertical shooting, rotate the camera so that the grip is at the top. Rotating the camera in the opposite direction will have the grip bump into the tripod mount.
- Before attaching or detaching the lens, set the tripod mount back to its normal position (horizontal shooting position). Otherwise, the tripod mount may bump into the camera grip or pentaprism and prevent the lens from being attached to or detached from the camera.
- If the EOS camera has a built-in flash, the pentaprism may prevent the tripod mount from being rotated to the top of the lens.

Using the Tripod Mount (Sold separately)

Attaching and Detaching the Tripod Mount

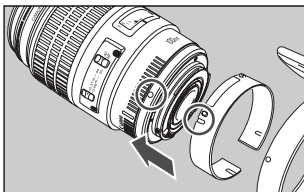
To attach the tripod mount, follow the illustrated procedure below. To remove the tripod mount, follow the procedure in reverse.



1 Align the tripod mount adapter's index  with the lens mount index. Push in the adapter onto the back of the lens.

- The tripod mount adapter's inner lugs should slide into the grooves on the lens barrel. The adapter should not be able to rotate around the lens barrel.

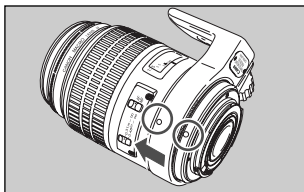

2 Loosen the tripod mount's lock knob. Align the lens mount index and the tripod mount's index, and slip on the tripod mount.

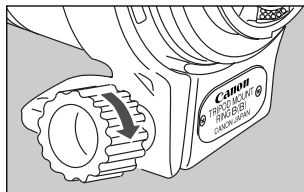

3 Rotate the tripod mount to the desired position and tighten the lock knob.

- You can loosen the orientation lock-knob on the tripod mount to allow it to rotate as needed to fit a particular camera model for switching between vertical and horizontal positions.

 Depending on the EOS camera model, if a battery pack or vertical grip is attached, the tripod mount may bump into it. If that is the case, remove the battery pack/vertical grip or the tripod mount.

9. Filters (Sold Separately)

You can attach filters to the filter mounting thread on the front of the lens.



- Filters and the macro flash cannot be used on this lens at the same time.
- If you need a polarizing filter, use the Canon Circular Polarizing Filter (58mm).
- To adjust the polarizing filter, first remove the lens hood.

10. Extension Tubes (Sold Separately)

You can attach Extension Tube EF12 II or EF25 II for magnified shots. The shooting distance and magnification are shown below.

	Camera-to-Subject Distance (mm)		Magnification	
	Near	Far	Near	Far
EF12 II	314	1002	1.19×	0.12×
EF25 II	319	606	1.39×	0.26×



Manual focusing is recommended for accurate focusing.

11. Close-up Lenses (Sold Separately)

Attaching a 250D or 500D (58mm) Close-up Lens enables close-up photography.

The magnification will be as follows.

- Close-up Lens 250D: 1.44x - 0.40x
- Close-up Lens 500D: 1.28x - 0.20x



Manual focusing is recommended for accurate focusing.

12. Macro Flash (Sold Separately)

The Canon Macro Ring Lite MR-14EX or the Macro Twin Lite MT-24EX enables fully automatic macro flash photography up to 1x magnification in E-TTL autoflash mode.



- For information on operating the Canon Macro Ring Lite MR-14EX or the Macro Twin Lite MT-24EX, refer to the individual instruction booklets.
- Using aperture-priority AE (**Av**) or Manual (**M**) picture-taking modes are recommended for macro photography as it is easy to adjust depth of field and exposure in these modes.

Specifications

Focal Length/Aperture	100 mm f/2.8
Lens Construction	8 groups, 12 elements
Minimum Aperture	f/32
Angle of View	Diagonal: 24° Vertical: 14° Horizontal: 20°
Min. Focusing Distance	0.31 m/1.0 ft.
Max. Magnification	1 ×
Field of View	24 × 36 mm/0.9 × 1.4 in. (at 0.31 m)
Filter Diameter	58 mm
Max. Diameter and Length	78.6 × 118.6 mm/3.1 × 4.7 in.
Weight	580 g/20.5 oz
Hood (Sold Separately)	ET-67
Lens Cap	E-58U
Case (Sold Separately)	LP1219
Tripod Collar (Sold separately)	Ring-type tripod mounting socket B (B) (comes with the EF100mm f/2.8 MACRO USM adapter)

- The lens length is measured from the mount surface to the front end of the lens. Add 21.5 mm when including the lens cap and dust cap.
- The size and weight listed are for the lens only, except as indicated.
- The EF1.4X II/EF2X II extenders cannot be used with this lens.
- Aperture settings are specified on the camera.
- All data listed is measured according to Canon standards.
- Product specifications and appearance are subject to change without notice.

Canon